

# Installation Manual

Montageanleitung  
Instructions de montage  
Istruzioni per il montaggio

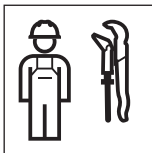

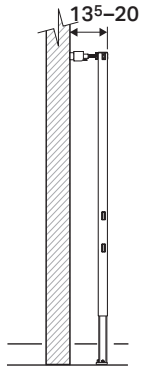

1

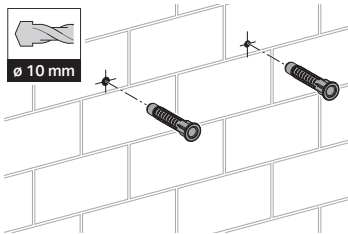

2

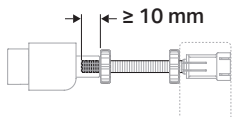
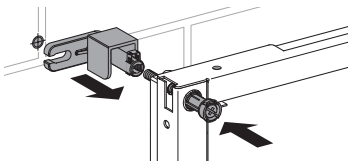

3

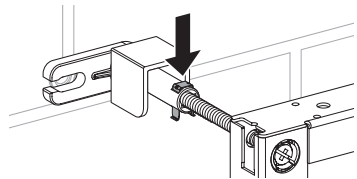

4

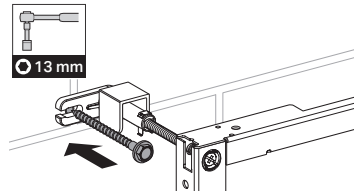

5

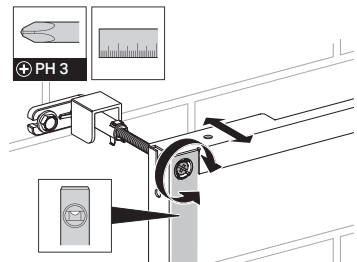

6

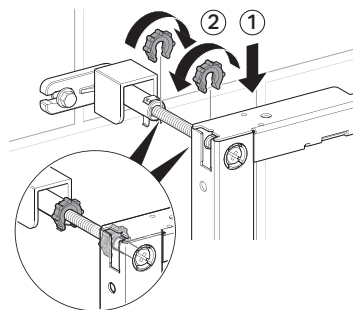

Geberit International AG

Schachenstrasse 77

CH-8645 Jona

T +41 55 221 63 00

F +41 55 221 63 16

[documentation@geberit.com](mailto:documentation@geberit.com)

[www.geberit.com](http://www.geberit.com)